



FORD F-150 2021

INSTALLATION MANUAL

CAB SPOILER

PART #: VML3Z-9944210-A

**READ CAREFULLY
BEFORE INSTALLATION**

**WASH BEFORE
INSTALLING**

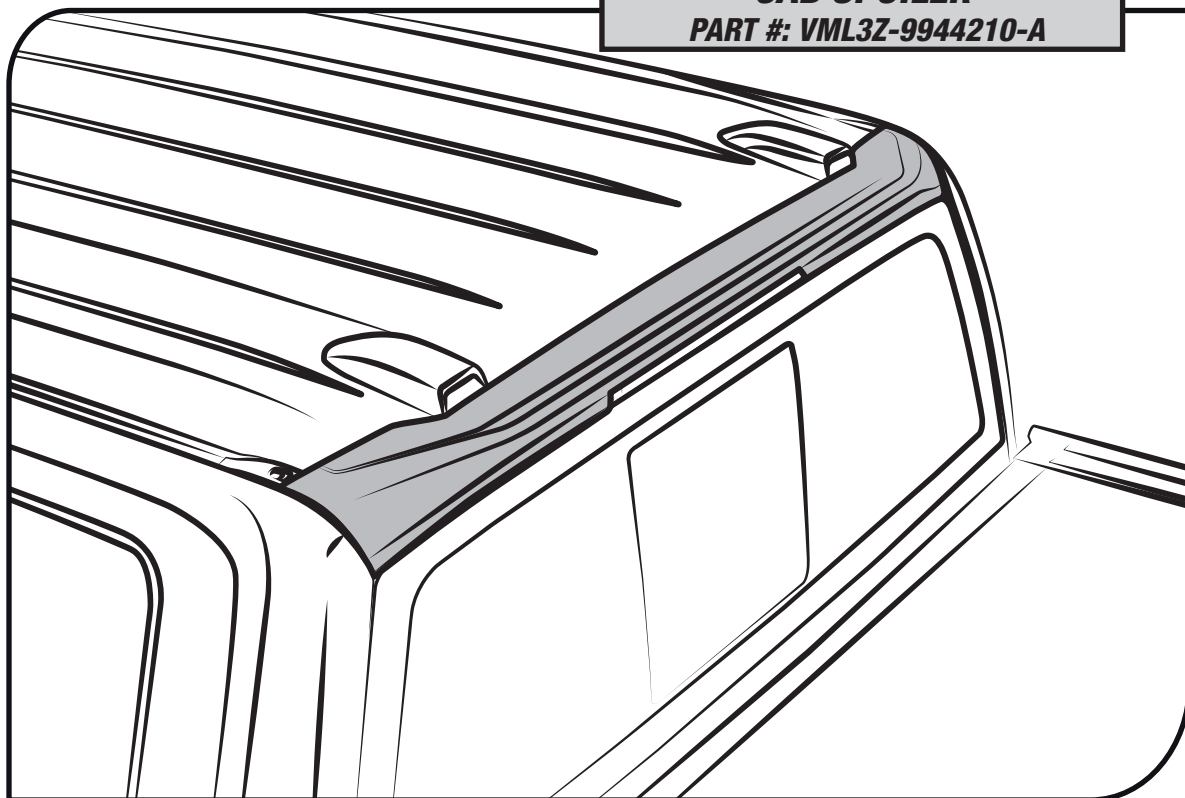

**WE RECOMMEND
2 PERSONS FOR
INSTALLATION**

AFTER INSTALLING

DO NOT WASH CAR



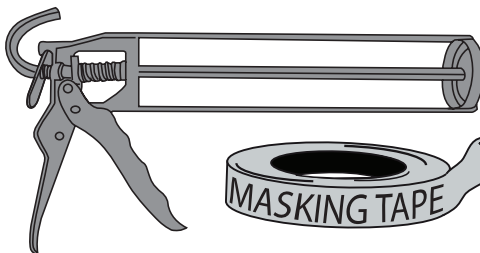

24 hrs

TOOLS

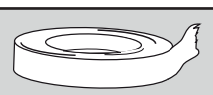

CHECK LIST

***ALREADY INSTALLED ON THE PART**

ITEM	DESCRIPTION	DRAWING	AMOUNT
A	*VHB TAPE		N/A
B	POLYURETHANE ADHESIVE 310 ml		1 PC



INSTALLATION MANUAL

The ideal temperature range of the part and the vehicle when installing must be 16°C (60°F) to 40°C (104°F), this guarantees a correct assembly.

1 CLEAN

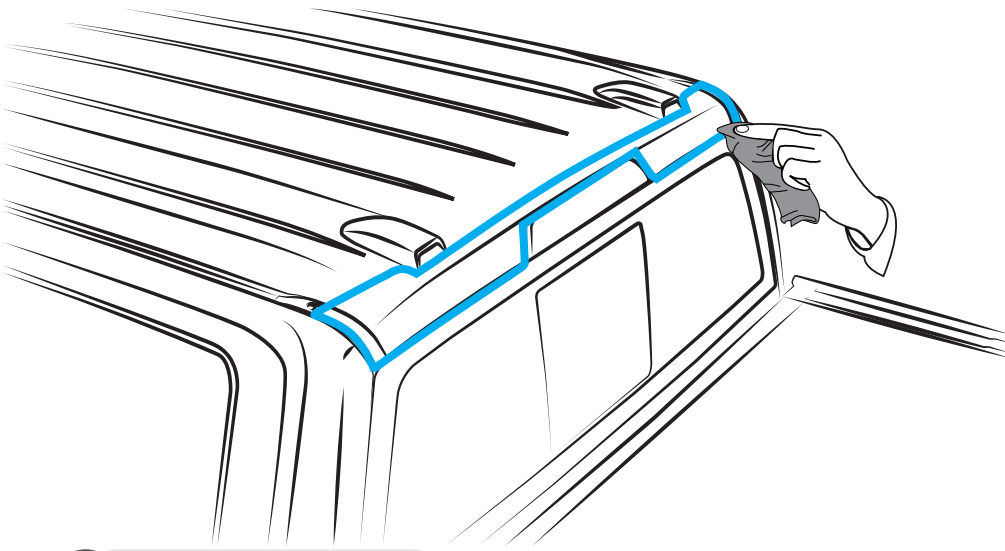

REMOVE ANY RINSE AID OR GLOSS ENHANCERS RESIDUE



2 TEST FIT THE PART

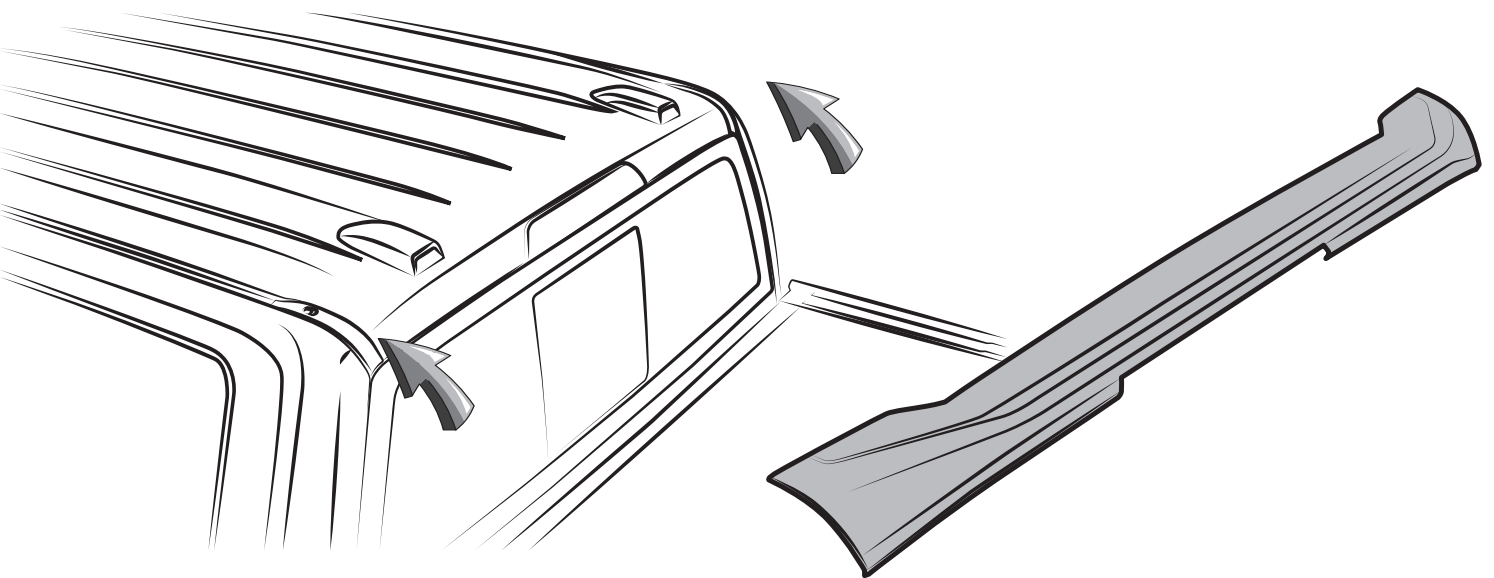

3 MARK

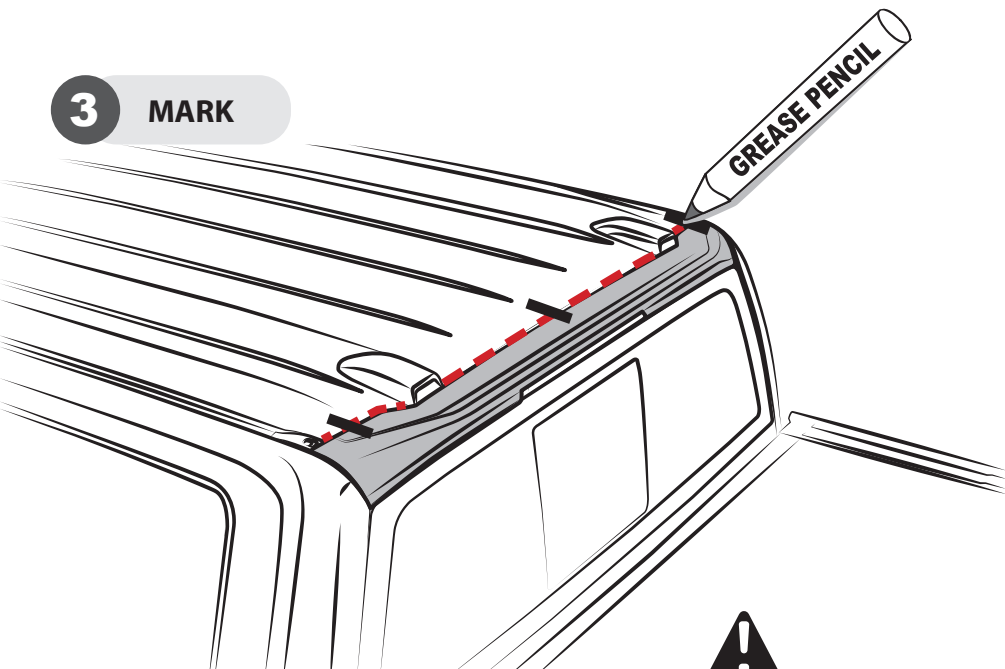

ALIGN & CENTER

CENTER ON BOTH SIDES

DRAW CENTER HASH MARK WITH GREASE PENCIL ON CAB SPOILER AND SHEET METAL, THIS WILL ENSURE CAB SPOILER WILL BE CENTERED TO GREASE PENCIL OUTLINE.



INSTALLATION MANUAL

4 CLEAN INNER CHANNEL

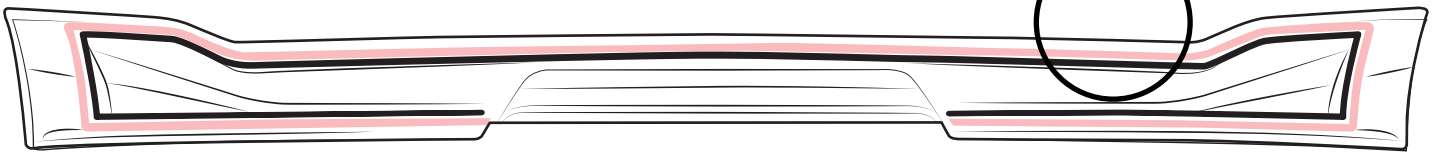
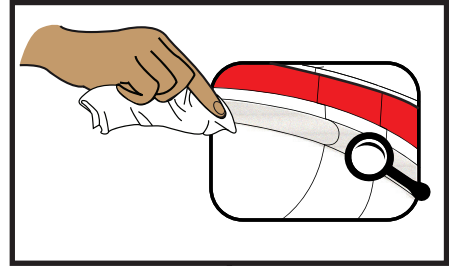

5 PEEL

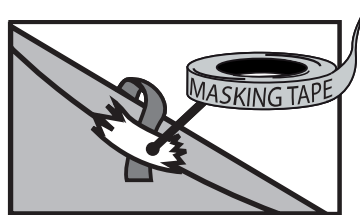
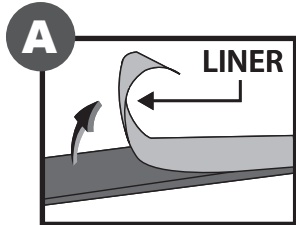
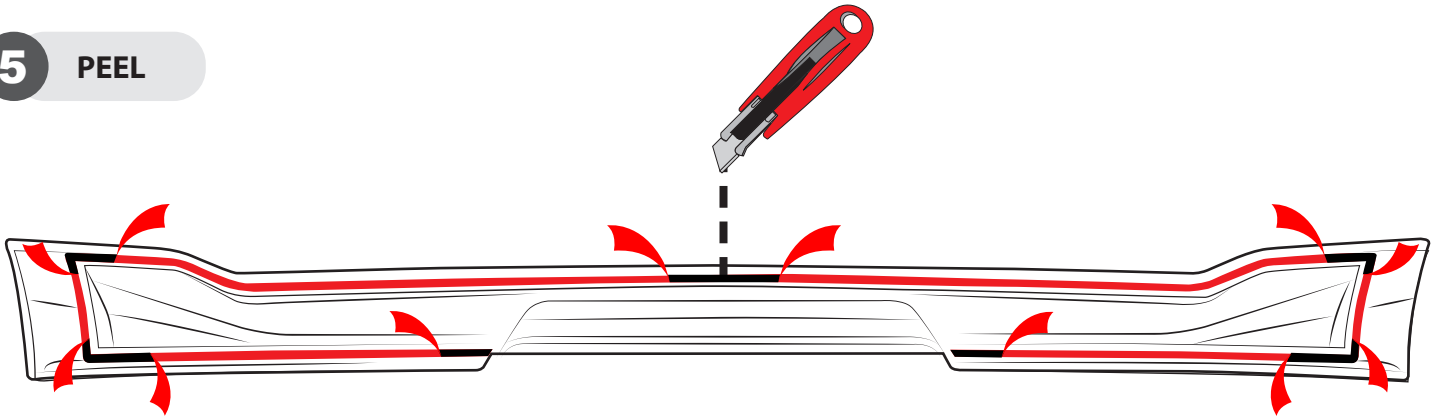

6 APPLY POLYURETHANE ADHESIVE

! POLYURETHANE ADHESIVE MUST NEVER TOUCH THE DOUBLE SIDED TAPE

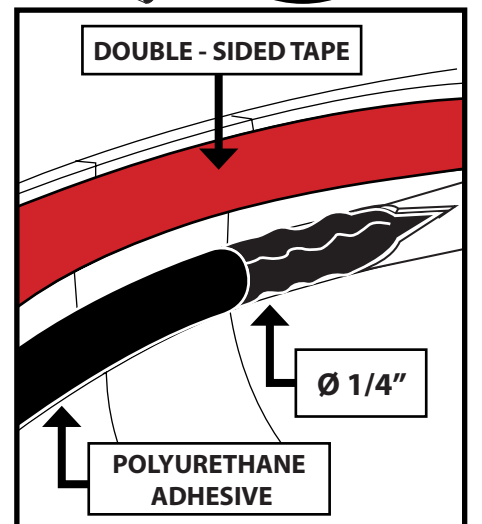
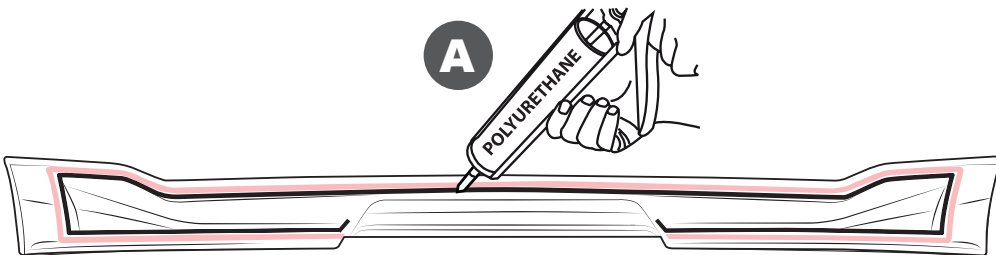
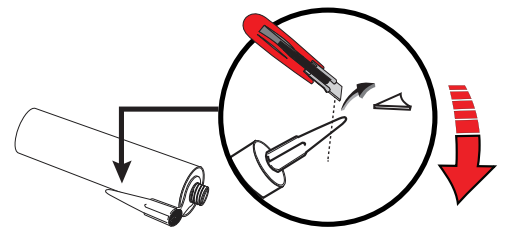



FORD F-150 2021

INSTALLATION MANUAL

7 PLACE

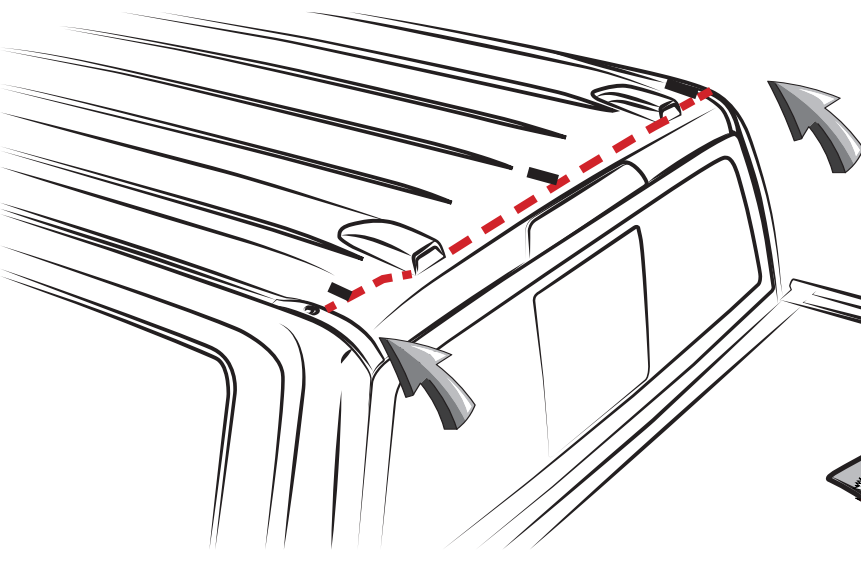

WARM SURFACES WITH HEAT GUN IF SURFACE TEMPERATURE IS TOO COLD.

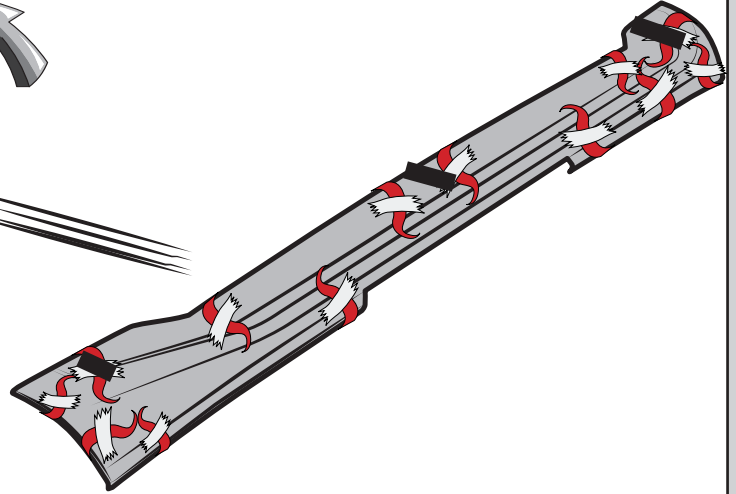

8 REMOVE LINER

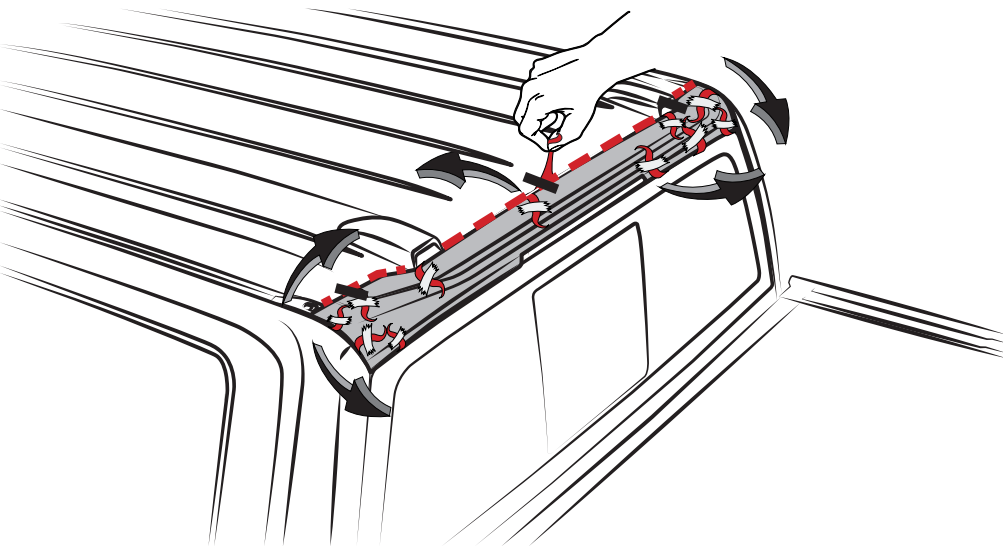

PRESS WHILE THE LINER IS REMOVED

9 PRESS FIRMLY

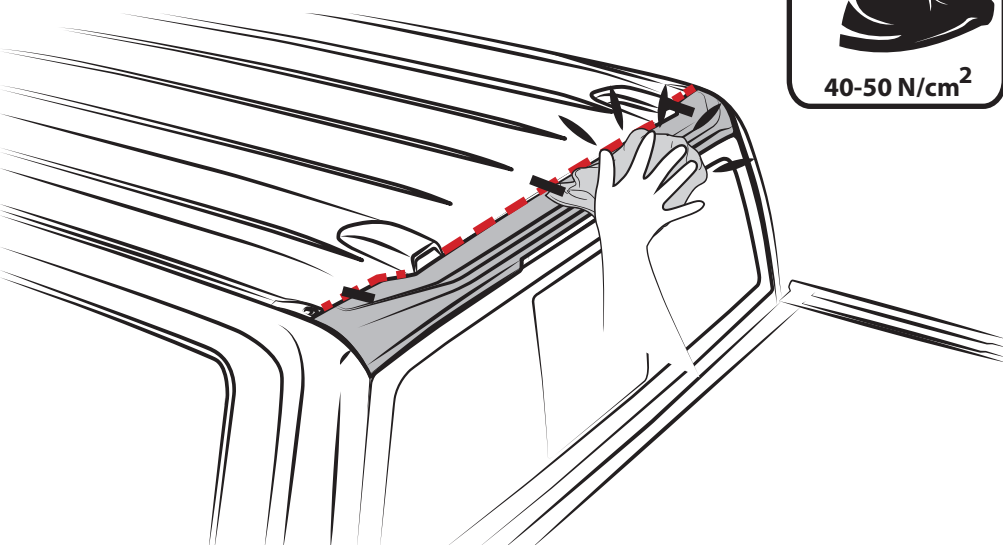

DURING APPLICATION, THE VEHICLE, ADD ON PARTS AND TAPE MUST BE AT OR ABOVE 16 °C OR 60 °F. A FULL SURFACE CONTACT BETWEEN TAPE AND SUBSTRATE IS IMPORTANT FOR GOOD ADHESION PERFORMANCE. CONTACT IS ACHIEVED BY APPLYING PRESSURE. IN PRACTICE A PRESSURE BETWEEN 40 AND 50 N/CM² IS USUALLY NEEDED.



10 CLEAN OFF GREASE PENCIL MARK

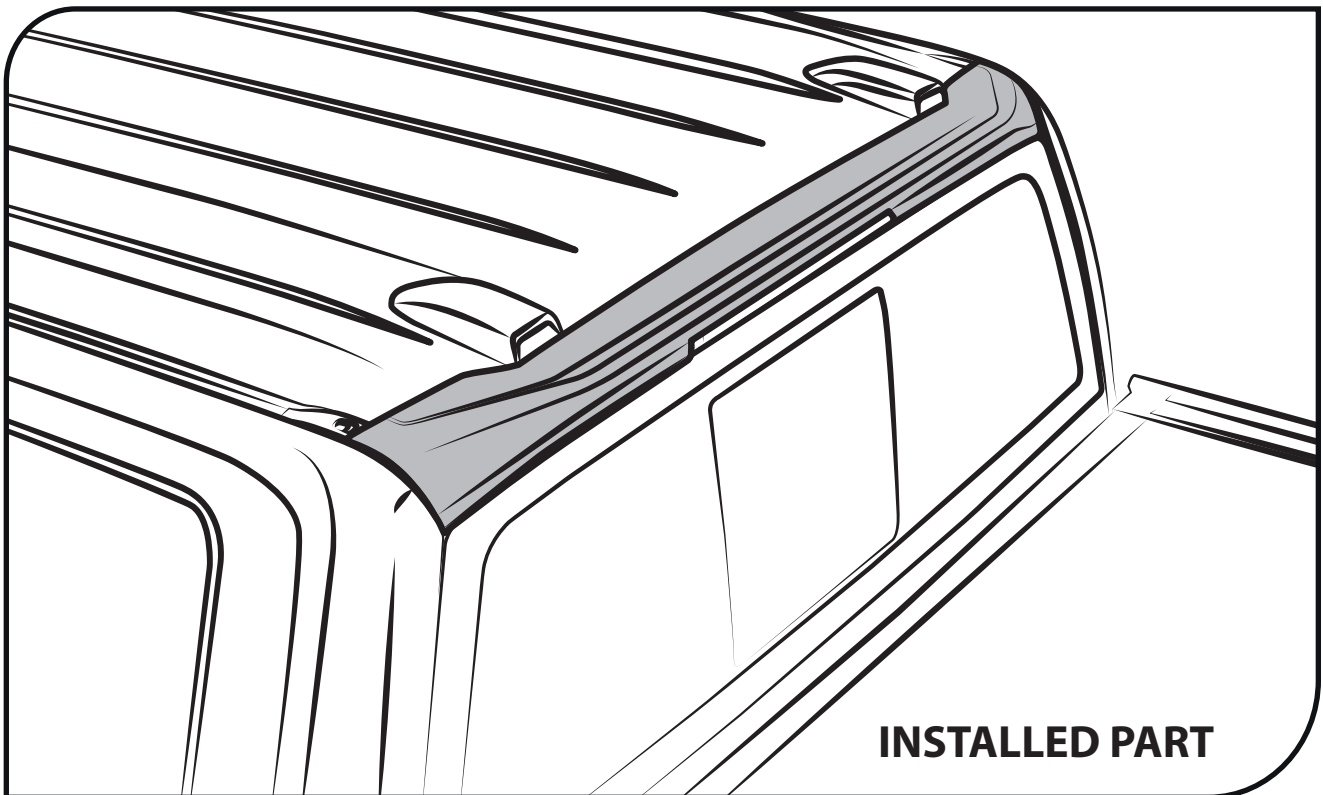
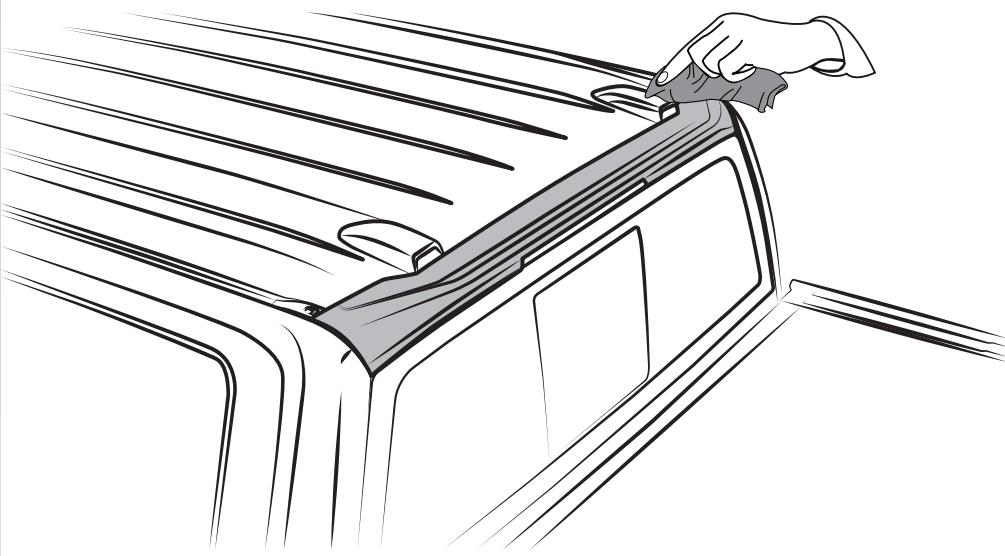



LIMITED WARRANTY

All Ford part numbers provided by AIR DESIGN USA LLC are warranted to be from defects in materials or workmanship on products properly installed per the installation instructions provided with the product. This warranty covers repair or replacement of any defective product at no charge during the applicable warranty period listed below. Labor for replacement or service of defective product is not paid or reimbursed by AIR DESIGN USA LLC.

WARRANTY PERIOD		
	USA	Outside USA
Product which appears on New Vehicle Monroney Label (window stickers)	Coverage which matches new vehicle warranty--- Ford - 3 years or 36,000 miles whichever comes first; Lincoln 4 years or 50,000 miles whichever comes first	Coverage which matches new vehicle warranty--- Ford - 3 years or 60,000 kilometers whichever comes first; Lincoln 4 years or 80,000 km whichever comes first
Part purchased and installed during or after the original vehicle warranty	Whichever of the following options which provides the greater benefit to the customer: 1) 2 years / unlimited miles or 2) The remainder of the new vehicle warranty	Whichever of the following options which provides the greater benefit to the customer: 1) 2 years / unlimited kilometers or 2) The remainder of the new vehicle warranty

This limited warranty does not cover any damage, defect or malfunction caused by misuse, abuse, accident, improper installation, modification or improper or lack of maintenance. Incidental and consequential damages are not recoverable under this warranty. This warranty offers you specific legal rights. You may have additional or other rights as which vary from vary from state to state or province to province.

If you experience a warranty issue with this product please visit your Ford dealer. If the repair is covered by the warranty above and completed by the dealership, labor is also covered by Ford -- Ford Warranty and Policy -- Section 3

Note to dealer:

Ford dealers should contact Air Design USA LLC by phone at: **+1 (760) 435 0095** and ask to speak to the warranty administrator or by email to: **billy@airdesignusa.com**